



StoVentec Panel Facades Application guideline

It should be noted that the following details, illustrations, general technical information, and drawings contained in this brochure are only general proposals and details which merely describe the basic functions schematically. No precise dimensions are included. The applicator/client is independently responsible for determining the suitability and completeness for the product in question. Neighbouring works are described only schematically. All specifications and information must be adjusted or agreed in the light of local conditions and do not constitute work, detail or installation plans. The technical specifications and product information in the Technical Data Sheets and in system descriptions/certificates must be observed.

Contents



System information

System description	4
System cross-sections	6
Installation requirements	6
Working drawings	7



Application of the system

Sub-construction/insulation	8
Measuring the facade	8
Installation - wall brackets	10
Installation - insulation	11
Installation - vertical carrier profiles	12
Installation - agraffe profiles	13
Panel	15
Preliminary work (applies only to StoVentec Stone Massive)	15
Installation - panel	15



Details

Plinth	17
Plinth formation	17
Installation - starter track	17
Installation - ventilation profiles	18
Corner formation	18
External corner	18
Internal corner	19
Connections	19
Parapet	19
Connection - window sill	20
Reveal formation	20
Lintel formation	21
Lintel formation with solar protection	21
Fire barrier	22
Horizontal fire barrier	22
Ceiling cladding	22
Ceiling cladding with StoVentec Glass	22
Connection ceiling/upward-oriented facade with open joint	23

System description

StoVentec Glass

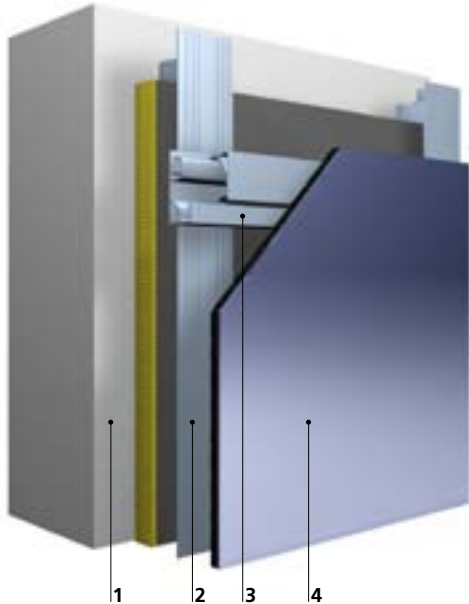

1 Insulation:

Sto-Mineral Fibre Board 033 RSC/035 RSC Fix
 Insulation board made of mineral wool, non-combustible, fire class A1 in accordance with EN 13501-1, black fleece lamination on one side, melting point > 1,000°C, thermal conductivity group 033 or 035
 Alternatively: Sto-Glass Wool Board 032 RSC Fix, thermal conductivity group 032
 Note: It is possible to use the one-dowel-technique for Sto-Mineral Fibre Board 035 RSC Fix and Sto-Glass Wool Board 032 RSC Fix subject to project-related approval by the insulant supplier.

2 Vertical sub-construction:

Sto-Stainless Steel Wall Bracket and Sto-Aluminium T-Profile
 Sub-construction made of stainless steel wall brackets and aluminium T-profiles
 Stainless steel wall brackets with minimised thermal bridging, optimised installation, maximum functional precision

3 Horizontal agraffe profiles:

StoVentec Aluminium Agraffe Profile
 Agraffe profile for easy positioning and mounting of the panel, high "resistance to torsional stiffness"

4 Cladding:

StoVentec Glass Panel
 Factory-produced glass panel for mounting, concealed fixing spots, available in different RAL colour shades as well as with individual screen printing

StoVentec Glass

Ventilated rainscreen cladding system with glass panels

Area of application	<ul style="list-style-type: none"> Existing and new buildings subject to fire protection regulations Onto all load-bearing anchorage substrates
Properties	<ul style="list-style-type: none"> System weight: approx. 30 kg/m² Levels unevenness by means of an adjustable stainless steel/aluminium sub-construction Improved sound insulation by up to 10 dB Full-surface bonding prevents dropping of the system in case of glass breakage caused by mechanical damage Low thermal bridge coefficient thanks to stainless steel wall brackets Optimal building physics through back-ventilation Highly weather-resistant Limited combustibility Building inspectorate approved as facade cladding and ceiling underside Subsequent element replacement (in case of damage)
Appearance	<ul style="list-style-type: none"> Glass surface Concealed fixing Resistant, smooth surface ensuring low maintenance costs for cleaning Gloss surface with depth effect Wide colour variety (RAL colour shades, individual screen printing, etc.), no limitations to the lightness value Panels can be delivered in customised formats for any type of joint pattern Bevelling of the carrier board edges where required Glass projection towards carrier board edge is approval-compliant up to 4 cm Maximum panel format: 1.25 x 2.6 m (larger formats can be realised in individual cases, subject to approval)
Application	<ul style="list-style-type: none"> Fitting of factory-produced panels in the sub-construction at the construction site Installation possible in all weathers Fast installation Complete detail solutions
Approvals	<ul style="list-style-type: none"> The relevant European and/or national approvals apply.

Important notes

- The panels cannot be subsequently modified. Precise measuring including the joint pattern is therefore imperative.
- For types with glass projection, markings from the glass projection as a result of unfavourable light conditions and certain colour shades cannot be excluded.
- Before panel production is started, the planner/building owner or applicator is required to approve the colour shade (by means of a colour sample) and the panel production drawings. Minor colour deviations are due to technical reasons.
- Tempered safety glass is used for StoVentec Glass Panels. Alternatively and upon request of the customer, tempered safety glass subject to a heat-soak test (ESG-H) can be used.
- For some colour shades (e.g. white, yellow and red shades), glass which is low in iron oxide (white glass) may be required. This can be realised at the request of the customer.
- Customised panes and bevel cuts as well as required openings and recesses have to be discussed with the system supplier beforehand. Observe the technically required minimum radii.

System description

StoVentec Stone Massive



1 Insulation:

Sto-Mineral Fibre Board 033 RSC/035 RSC Fix
 Insulation board made of mineral wool, non-combustible, fire class A1 in accordance with EN 13501-1, black fleece lamination on one side, melting point > 1,000°C, thermal conductivity group 033 or 035
 Alternatively: Sto-Glass Wool Board 032 RSC Fix, thermal conductivity group 032
 Note: It is possible to use the one-dowel-technique for Sto-Mineral Fibre Board 035 RSC Fix and Sto-Glass Wool Board 032 RSC Fix subject to project-related approval by the insulant supplier.

2 Vertical sub-construction:

Sto-Stainless Steel Wall Bracket and Sto-Aluminium T-Profile
 Sub-construction made of stainless steel wall brackets and aluminium T-profiles
 Stainless steel wall brackets with minimised thermal bridging, optimised installation, maximum functional precision

3 Horizontal agraffe profiles:

StoVentec Aluminium Agraffe Profile
 Agraffe profile for easy panel positioning and mounting, high "resistance to torsional stiffness"

4 Cladding:

StoVentec Stone Massive Panel
 Factory-produced natural stone panel with undercut anchor, concealed fixing, available in various types of stone: honed, polished, sand-blasted as well as sand-blasted and brushed

StoVentec Stone Massive ventilated rainscreen cladding system with natural stone panels

Area of application	<ul style="list-style-type: none"> Existing and new buildings Onto all load-bearing anchorage substrates
Properties	<ul style="list-style-type: none"> System weight: up to more than 100 kg/m² depending on the type and thickness of the natural stone Levels unevenness by means of an adjustable stainless steel/aluminium sub-construction Improved sound insulation by up to 10 dB Low thermal bridge coefficient thanks to stainless steel wall brackets Optimal building physics through back-ventilation Non-combustible Can be used as facade and ceiling cladding Subsequent element replacement (e.g. in case of damage)
Appearance	<ul style="list-style-type: none"> Solid natural stones such as Kirchheim shell limestone, sandstone, dolomite, etc. Available surface treatment: honed, polished, sand-blasted as well as sand-blasted and brushed Fixing with concealed undercut anchors
Application	<ul style="list-style-type: none"> Fitting of factory-produced panels in the sub-construction at the construction site Installation possible in all weathers Fast installation Complete detail solutions
Approvals	<ul style="list-style-type: none"> The relevant European and/or national approvals apply.

Important notes

- Subsequent modification of the panels by the customer is only possible to a very limited extent and in close coordination with the system supplier. Precise measuring including the joint pattern is therefore imperative.
- Before panel production is started, the system supplier must be notified by the planner/building owner or applicator about the release of the stone including the desired surface treatment (by means of an original sample) and the panel drawings.
- Minor deviations in colour and texture are due to product characteristics.
- Bevel cuts as well as required openings and recesses have to be discussed with the system supplier beforehand. Observe the technically required minimum radii.
- The building owner/planner has to specify the treatment of visible panel edges and discuss its feasibility with the system supplier.

System sections

Installation requirements

Vertical projection

StoVentec Glass/StoVentec Stone Massive

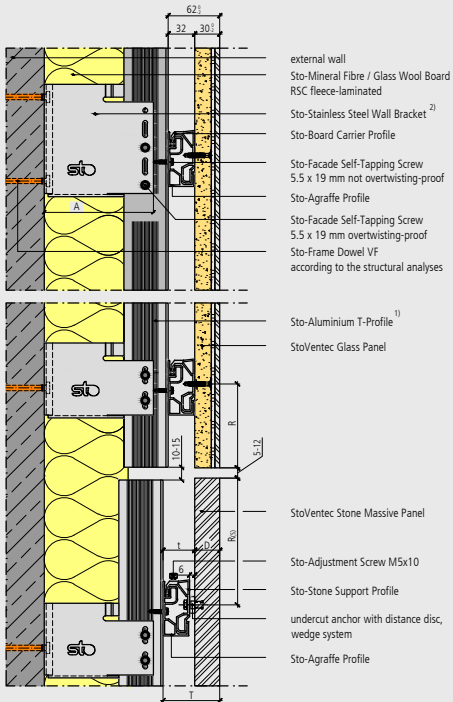

A	= projection of wall bracket (see EAG 004)
D	= thickness of stone slab in accordance with material and structural analyses
R	= distance to edge in accordance with approval Z-33.2-658
R ₁₀	= edge spacing of undercut anchor in accordance with structural analyses
T	= overall structure, natural stone element of front edge of T-profile
t	= structure depth, rear side, stone to leading edge T-profile (36 mm system wedge)

1) Align profile joints with position of horizontal panel joints.

2) Arrangement of fixed and sliding point brackets in accordance with structural analysis / factory planning

Horizontal projection

StoVentec Glass/StoVentec Stone Massive

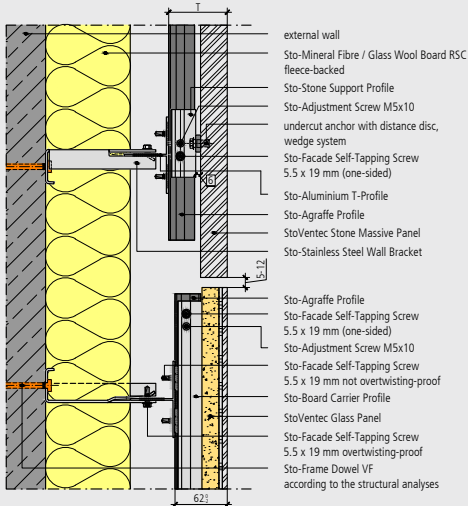

T = overall structure, natural stone element of front edge of T-profile

- If the substrate is load-bearing and able to bear the load of the facade and/or ceiling cladding, a suspended, ventilated rainscreen cladding system can be properly installed based on a project-related wind load calculation as well as a project-related structural analysis. The system is ideal for problematic substrates. Even large unevenness in the anchorage substrate can be compensated for.
- Doors, windows, roller shutter boxes, parapets, horizontal surface caps and window sills must be installed before the facade or ceiling cladding. The planned system structure must be taken into account when determining an adequate projection of parapets and horizontal surface caps as well as window sills.
- The building shell tolerance must be determined and the required wall bracket projections specified as compared to the initial planning.
- As part of his working drawings and before installation of the complete system, the applicator must specify and coordinate the required formation of details and system connections. Besides the project-related structural analyses and, where required, the system approval, it is the project-related conditions that must be considered in particular
- When it comes to structural analyses and/or the preparation of layout plans, we would be happy get you in contact with experienced service providers. As a preparatory measure and depending on the anchorage substrate, it may be necessary to perform project-related dowel extraction tests. Also for these tasks, we can get you in contact with competent partners.

Working drawings

Step 1: Specification/installation - wall bracket and T-profile

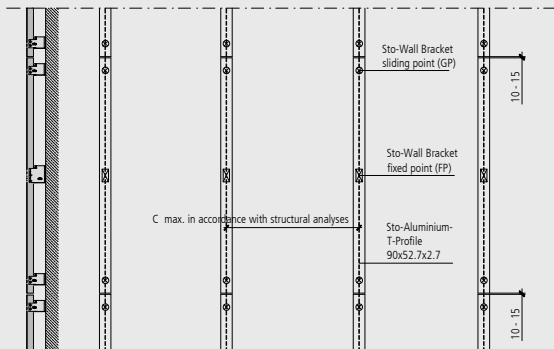

Step 2: Specification/installation - agraffe profile

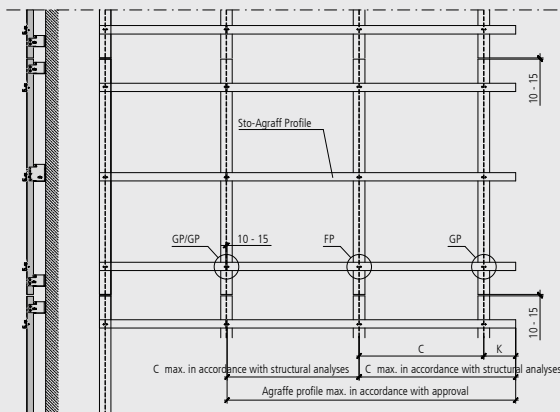

Step 3: Installation - StoVentec Glass Panel

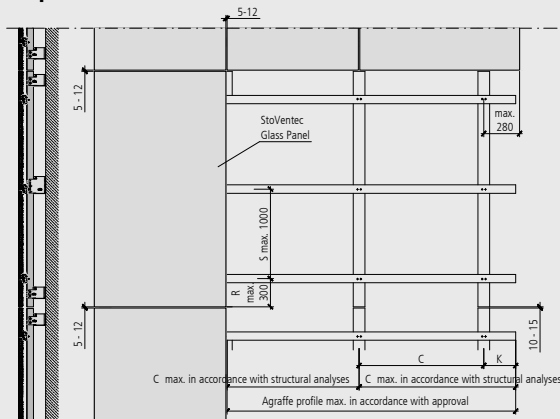

C = span width agraffe profile in accordance with approval Z-32.2-658 / Structural analyses / Working drawings
 K = collar arm agraffe profile in accordance with approval Z-32.2-658 / Structural analyses / Working drawings
 $K \leq C$; $K \leq 250$ mm
 R = distance to edge in accordance with approval Z-32.2-658
 S = axis spacing Agraffe Profile in accordance with approval Z-32.2-658 / Structural analyses / Working drawings
 Rod diagram T- and agraffe profile in accordance with approval Z-32.2-658 / Structural analyses / Working drawings
 Design of fixed and sliding points, see EAG 017 and 018

Important notes

- Measuring carried out at the object lies in the applicator's area of responsibility and serves as basis for structural analyses, working drawings and panel ordering
- The T-profile and agraffe profile joints (horizontal and vertical) must be matched to the panel joints.
- Where required, take fire barriers into account
- The current system drawings [EAG010](#), [EAG011](#), [EAG014](#), [EAG015](#), [EAG016](#) must be observed during planning.
- Determine the existing building shell tolerances for the entire facade surface at the marked profile axes using a reference line or laser. The required wall bracket projections must be specified.
- Observe the arrangement of the building expansion joints. Where required, additional profile axes must be provided.
- The wall brackets should project at least 2 cm from the insulation to allow optimum screw fixing.
- To determine the ideal wall bracket length, reduce the spacing between the bare wall and the front edge of the finished facade by the following:
 - approx. 80 mm in case of StoVentec Glass
 - approx. 55 mm plus stone thickness in case of StoVentec Stone Massive

Sub-construction / insulation

Measuring the facade

1) Determining the base point

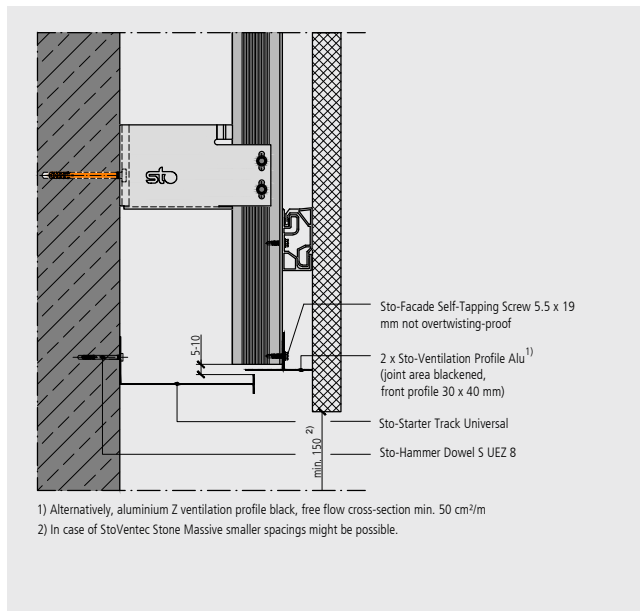

2) Marking the vertical profile axes



Mark the vertical profile axes according to the project-based structural analyses and working drawings while taking into account the planned joint pattern of the facade.



Centre line of the vertical profile axes

Note

The base point of the facade is to be set above ground level, balconies, patios, roof surfaces, etc. in a way which ensures continuous system ventilation and prevents the facade cladding from constant soaking due to spray water from neighbouring horizontal surfaces. The given reference points must be taken into account when specifying the relative elevations.

Sub-construction / insulation

3) Arranging the wall brackets



The arrangement of the wall brackets as fixed and sliding points in accordance with the project-based structural analysis and the working drawings must be determined on the already marked exterior profile axes.



The arrangement of the wall brackets is transferred to the centre line using a chalked string.



Mark the position of the fixed point wall brackets according to the project-related structural analyses and working drawings.



Mark the position of the sliding point wall brackets according to the project-related structural analyses and working drawings.



The offset of the profile to the dowel axis of approx. 20 mm must be observed. Important: The wall bracket can be installed on the left or right as required.

Installation - wall brackets



Product tip

Sto-Stainless Steel Wall Bracket

- Minimisation of thermal bridges
- 20 mm increments
- 50 to 300 mm projection with a material thickness of 1.5 mm or according to the structural analyses
- 300 to 600 mm projections with a material thickness of 2.5 mm or according to the structural analyses
- Can be used horizontally, e.g. for fire barriers
- Installation as wall and ceiling bracket (in combination with pendulum rods for large suspension heights)
- Available as fixed and sliding point wall brackets
- Integrated clamping spring



Product tip

Sto-Facade Screw Dowel

- Suitable for almost all solid anchorage substrates
- Highly resistant to structural loads
- Application according to the structural analyses



1

For installation of the wall brackets, the drill holes must be made by impact or turning, depending on the anchorage substrate and dowels and in accordance with the dowel approval. The specified minimum hole depth must be observed. The drill hole must be blown out in accordance with the specifications in the dowel approval.



2

Insert the wall brackets into the drill hole in pass-through installation, if necessary backed with thermal stop elements, as fixed or sliding point with facade screw dowels (dowel collars), taking into account the required tolerance compensation with the corresponding projection in accordance with structural specifications.



3

The wall brackets must be oriented plumb.



4

The dowel screws are tightened so that full surface of the dowel collar rests on the wall bracket and the screw head on the dowel collar. Galvanised screw heads must be painted or levelled out at the connection to the dowel collar with a flexible, permanently elastic bitumen-oil combination coating, depending on the dowel approval.

Notes

Sto-Facade Screw Dowels for Sto-Stainless Steel Wall Brackets

- When setting the facade screw dowels, the specifications of the dowel approval must be observed.
- Use the facade screw dowels according to the anchorage substrate and in accordance with the project-based structural analyses.

Sub-construction / insulation

Installation - insulation

Fixing diagram for insulation boards

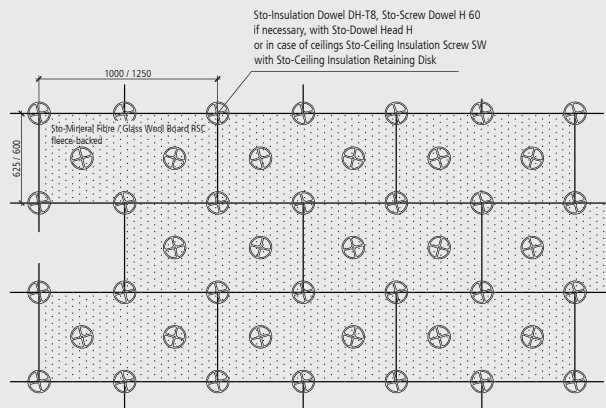

In case of rear ventilation gap $h < 6$ cm (see EAG 001, 002 and 006) do not install insulation dowels in the carrier profile area.
Consumption of insulation dowels, average of 5 pieces/m² in accordance with DIN 18516-1, in centre of panel 1 to 2 insulation dowels.

Tip

For insulants with the corresponding approval, the one-dowel technique can be used upon project-related coordination agreement with the insulation manufacturer. The specifications of the insulation and dowel supplier must be observed.

Information

Requirements to be met by the insulant

- Insulation board made of mineral or, alternatively, glass wool in accordance with EN 13162
- Insulant with external black fleece lamination
- Non-combustible A1 or A2 -s1,d0 according to EN 13501-1
- Insulant continuously water-repellent and permanently dimensionally stable

Important note

With a ventilation airspace of less than 6 cm, no insulation dowels can be set near vertical profile axes, since the gutters of the vertical carrier profiles go into the insulation level. In this case, the required insulation dowels must be installed next to the profile axes.



1
Insulation is carried out before the vertical carrier profiles are installed. Place the insulation boards in a bond pattern without gaps, score and press them over the wall brackets.



2
Secure the insulation boards against slipping with an average of 5 Sto-Insulation Dowels per m². Back-ventilation of the insulation must be excluded. When setting the insulation dowels, the anchorage depth of at least 20 mm must be observed. The insulant must not be compressed. Installation-related gaps in the insulation must be stuffed with the original insulation material.

Sub-construction / insulation

Installation - vertical carrier profiles



Product tip

Sto-Aluminium-T-Profile

- Specified screw fixing area
- Grooved texture for easy positioning of the drilling screws in the profile gutter and flange

Tip

- For each facade and ceiling surface, align the first and last axis and install it to the wall brackets according to the structural analyses. Then install a horizontal reference line for orientation of the remaining profiles. Alternatively, use a laser.
- Set the profiles, starting from the external axes and moving towards the centre.
- If aluminium / stainless steel rivets are used as connectors, suitable riveters and rivet jigs must be used to ensure the T-profiles are installed without bending.

Versions

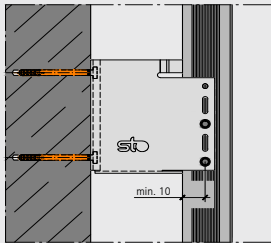

fixed point (FP)

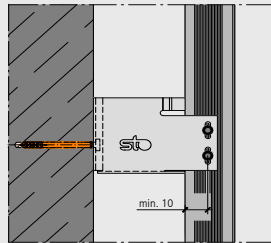

sliding point (GP)

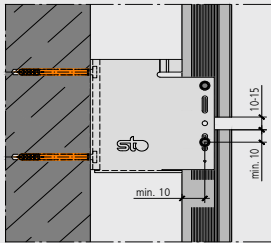

fixed / sliding point (FP/GP)

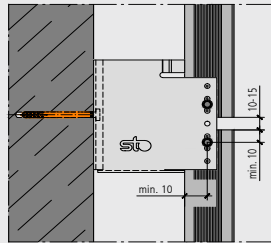

sliding / sliding point (GP/GP)



In case of a ventilation airspace of < 5 cm, score the insulant at the stem of the T-profiles. Cut the T-profiles using a mitre saw. Insert the T-profiles. Align the T-profiles to the reference line.

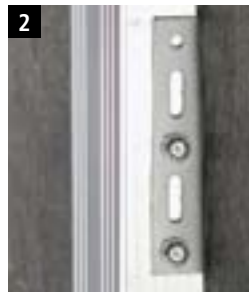

Screw on the T-profiles according to the structural analyses as fixed and sliding points with Sto-Self-Tapping Facade Screws 5.5 x 19 mm that cannot be over-tightened (alternatively, rivet with aluminium / stainless steel rivets according to structural analyses). For fixed points, screwing/riveting is carried out in the middle and lower round hole, subject to structural analyses.



For sliding points, screwing/riveting must be carried out centrally in the oblong holes of the wall brackets.



All profile joints must be formed with a joint width of at least 10 mm to cater for lengthwise thermally-induced expansion.

Sub-construction / insulation

Installation - agraffe profiles (tension-free)

Versions

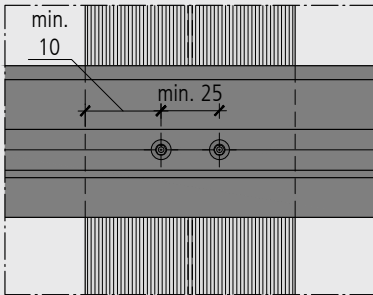

fixed point - Sto-Agraffe Profile

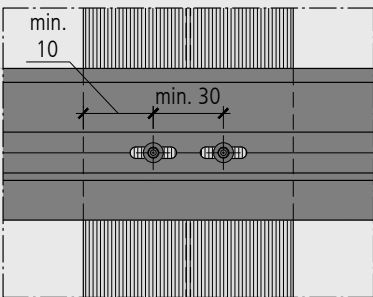

sliding point - Sto-Agraffe Profile

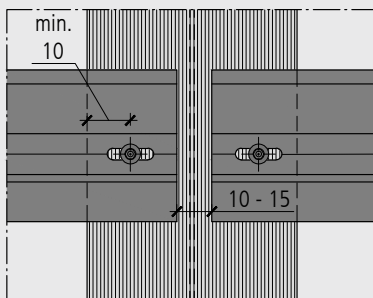

sliding / sliding point - Sto-Agraffe Profile

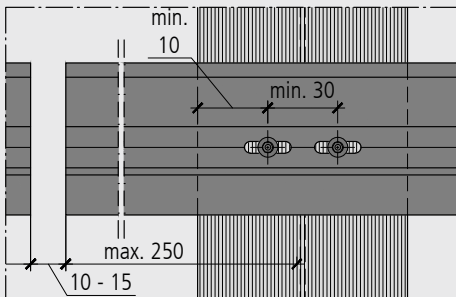

sliding / sliding point - Sto-Agraffe Profile with collar arm

Installation - agraffe profiles (tension-free)

Oblong hole formation

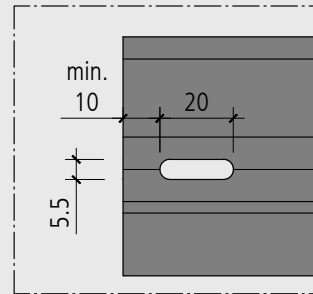

oblong hole detail

Important note

- Screw connections between the agraffe profile and the T-profile must be carried out using a StoVentec Self-Tapping Facade Screw 5.5 x 19 mm (without over-tightening protection) according to the structural analyses.

Positioning of agraffe profiles

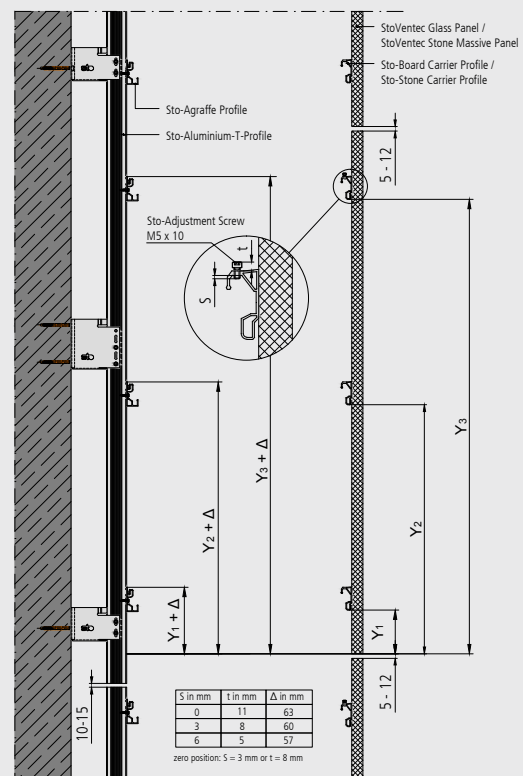

illustration without insulation

S = screw-in depth of Sto-Adjustment Screw

t = excess length of Sto-Adjustment Screw

Y = edge distance of board / stone carrier profile in accordance with production drawing

Sub-construction / insulation

Installation - agraffe profiles (tension-free)



1 Agraffe measuring and transfer to other profile axes using a spirit level and/or chalk line.



6 Blacken the sub-construction around the panel joints (e.g. using black spray paint or adhesive tape).



2 Install the agraffe profile (bar length in accordance with the installation requirements, maximum length must not be exceeded) without tension producing fixed and sliding points. Connect the T-profile to the agraffe using StoVentec Self-Tapping Facade Screws 5.5 x 19 mm (alternatively aluminium / stainless steel rivets can be used subject to the structural analyses).



3 In case of fixed points the agraffe profile can be pre-drilled on the marking line as required. Provide a fixed point with 2 screws/rivets for each agraffe profile.



4 At the sliding points, fasteners must be placed in the centre of the oblong holes (5.5 x 20 mm), which have to be produced on site.



5 Produce agraffe profile joints with a joint width of 10 to 15 mm to cater for lengthwise thermally-induced expansion.

Panel

Preliminary work (applies only to StoVentec Stone Massive)



1 Check and, where required, blow out the drill hole.



2 Insert the undercut anchor.



3 Apply a spacer disc.



4 Screw on the stone carrier profile in an adjustable and fixable manner (at the top) and align it.



5 Screw on the stone carrier profile rigidly (at the bottom) and align it.

Installation - panel

Adjustment range of adjustment screw

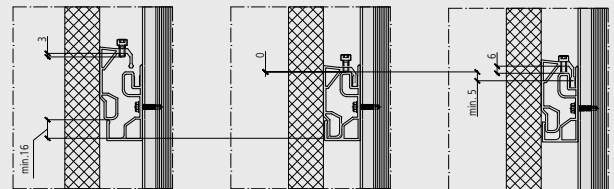

Required mounting height

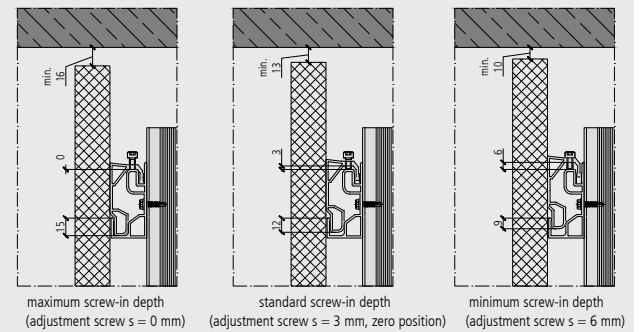

Protection against lateral movement

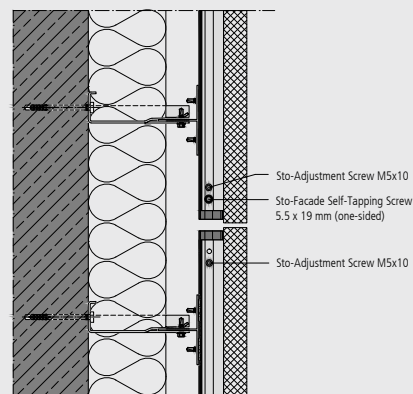

Only applicable to facade panels



Note

If it is necessary to temporarily place the panels on the floor/rack during installation, make sure to place them on a soft surface. This is imperative to prevent damage, e.g. in the area of the edges.

Panel



1 Remove borings from the agraffe profiles to allow for trouble-free agraffe panel fitting.



2 Drive the StoVentec Adjustment Screw (StoVentec Glass: M5 x 10 mm; StoVentec Stone Massive: M6 x 10 mm) into the top panel carrier profile (to zero position, screw-in depth set to 3 mm).



3a StoVentec Glass: use glass suction cups or a suction cup battery to mount the panel.



3b StoVentec Stone Massive: mount the panel either manually or using a belt.



4 Align the panels vertically and horizontally. Ensure that a consistent joint pattern (min. joint width for StoVentec Glass is 5 mm, max. joint width 12 mm) is maintained.



5 The panels are horizontally aligned by means of adjustment screws. During alignment, the panels should be slightly lifted to relieve the adjustment screws.



6a StoVentec Glass: tension-free panel fixing to the top panel carrier profile to prevent lateral movement, e.g. by using a unilateral plug connection or drilling screw.



6b StoVentec Stone Massive: tension-free panel fixing to a top panel carrier profile to prevent lateral movement, e.g. using a plug connection or drilling screw.

Important note

Clean the panel surfaces when dismantling the auxiliary tools (StoVentec Glass: use a standard glass cleaner).

Plinth

Plinth formation

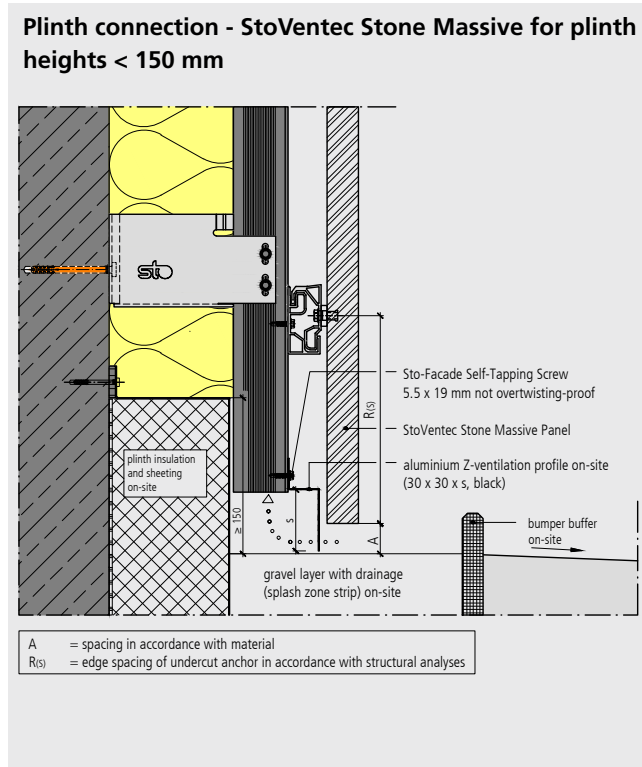
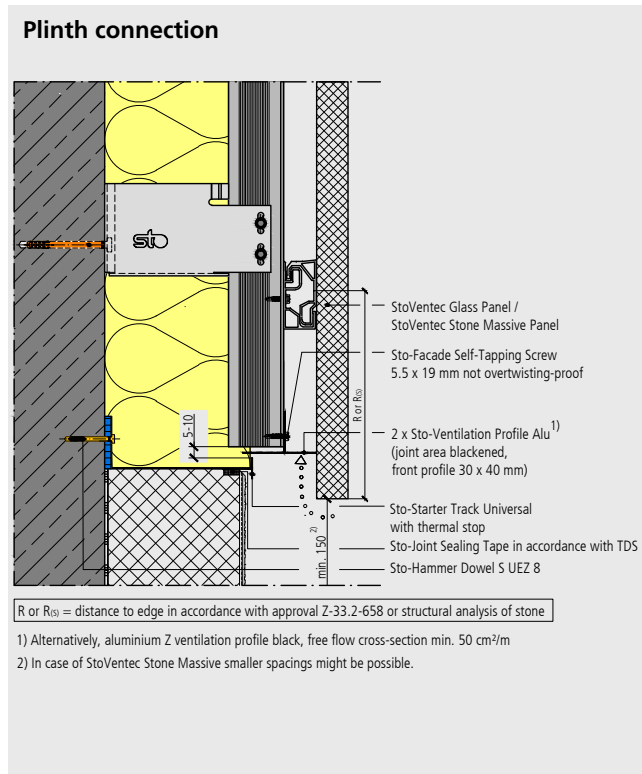

Installation - starter track



Before starting the installation work, the plinth height must be determined (see also page 8) and marked with a plumb line. The plinth and perimeter insulation has to be carried out according to the specifications and application guidelines of Sto AG.



The connection joint between the starter track and plinth insulation is sealed against driving rain with the Sto-Joint Sealing Tape.



The Sto-Starter Tracks Universal are mounted horizontally according to the insulation thickness and must rest neatly on the bare wall. Sto-Packing Shims and/or Sto-Thermocouples are used to compensate for unevenness in the wall. The starter tracks are fixed at intervals of approx. 33 cm with Sto-Hammer Dowels. Avoid twisting the tracks.



The starter tracks should be fixed to the exterior holes, if possible. Attach Sto-Starter Track Connectors to facilitate installation of the starter tracks.



Use the Sto-Starter Track Universal Corner Pieces at the building corners. The corner pieces can be adapted to the angle of the external corner.

Plinth

Installation - ventilation profiles



Product tip

Sto-Ventilation Profile Alu
Profile for securing system ventilation and small animal protection in the plinth area and the lower end of the system (dimensions 30 x 40 mm and 40 x 100 mm)



1 A joint of 5 to 10 mm is formed between the starter track and the Sto-Aluminium T-Profile.



2 For the ventilation profile, the insulation at the upper edge of the starter track is scored as needed.



3 Insert the back ventilation profile into the insulation.



4 A second ventilation profile covers the area between the T-profile and the back of the panel. Screw both ventilation profiles to the T-profile flanges together. The horizontal profile flanges can be arranged at the same level. The complete ventilation airspace from the front edge of the insulation to the back of the panel must be covered. Alternatively, an edged Z-shaped ventilation profile may be installed.

Corner formations

External corner

External corner - StoVentec Glass

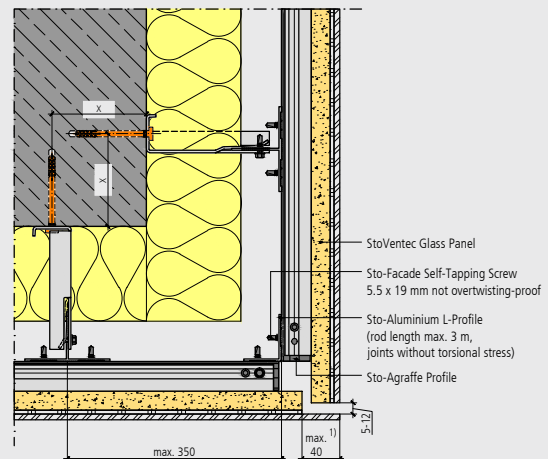

X = minimum edge distance in accordance with dowel approval

1) In case of unfavourable light conditions and certain colour shades, markings from the glass projection cannot be excluded.

External corner - StoVentec Stone Massive

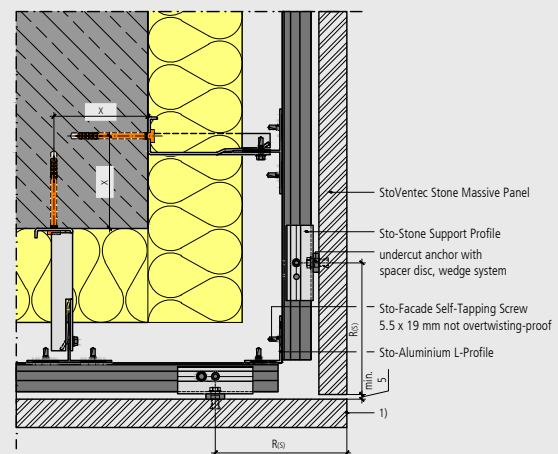

R(5) = edge spacing of undercut anchor in accordance with structural analyses

X = minimum edge distance in accordance with dowel approval

1) Working on front edge analogous to natural stone element surface in agreement with system supplier

Note

For system structures > 250 mm, special constructions may be required.

Corner formations

Internal corner

Internal corner StoVentec Glass

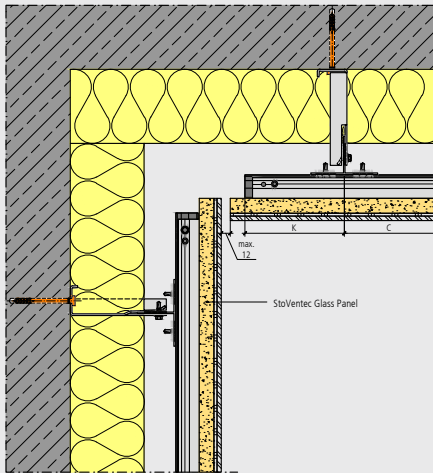

C = span width Sto-Agraffe Profile, see EAG 010 to 016
K = collar arm Sto-Agraffe Profile, see EAG 010 to 016

Internal corner - StoVentec Stone Massive

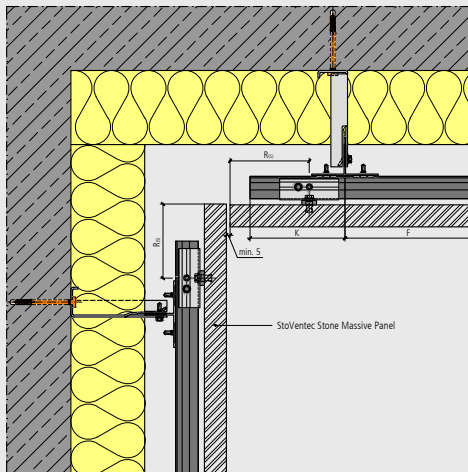

F = span width Sto-Agraffe Profile in accordance with structural analyses
K = collar arm Sto-Agraffe Profile in accordance with structural analyses
Re = edge spacing of undercut anchor in accordance with structural analyses

Note

Indented corner panel should be 30 mm wider.

Connections

Parapet

StoVentec Glass parapet ventilation with open joint

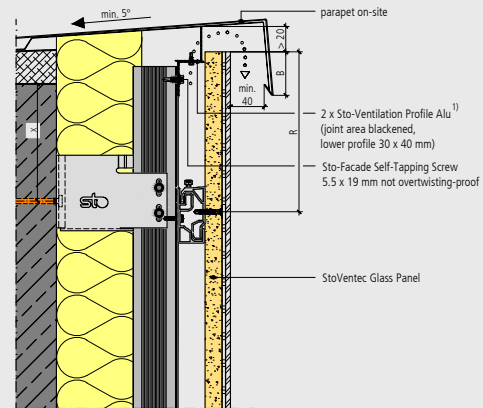

X = minimum edge distance in accordance with dowel approval
R = distance to edge in accordance with approval Z-33.2-658

Building height	B	(in accordance with trade regulations for metalwork in the roofing trade)
< 8 m	min. 50 mm	
8-20 m	min. 80 mm	
> 20 m	min. 100 mm	

1) Alternatively, aluminium Z ventilation profile black, free flow cross-section min. 50 cm²/m

Parapet ventilation with open joint StoVentec Stone Massive

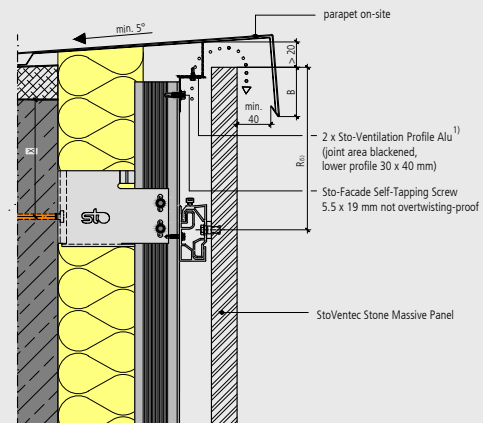

Re = edge spacing of undercut anchor in accordance with structural analyses
X = minimum edge distance in accordance with dowel approval

Building height	B	(in accordance with trade regulations for metalwork in the roofing trade)
< 8 m	min. 50 mm	
8-20 m	min. 80 mm	
> 20 m	min. 100 mm	

1) Alternatively, aluminium Z ventilation profile black, free flow cross-section min. 50 cm²/m

Notes

- In case of ventilation joints > 20 mm, two Sto-Ventilation Profiles Alu have to be installed in a Z-shaped arrangement (alternatively, Z-shaped ventilation profiles) to keep out small animals.
- Observe the required mounting height of the panels. See page 15.
- When the parapet cover is installed after the panels have been fitted, the upper end of the system must be temporarily covered.

Connections

Connection - window sill

Reveal formation

Ventilation window sill connection StoVentec Glass with open joint

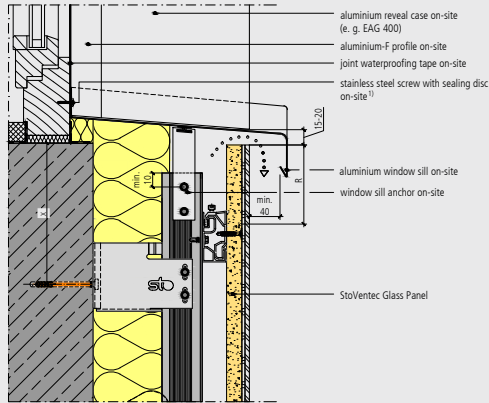

R = distance to edge in accordance with approval Z-33.2-658
 X = minimum edge distance in accordance with dowel approval
 wind-proofing, window waterproofing and fixing in accordance with RAL and/or window manufacturer's specifications.
 Installation of window sill in accordance with installation directives defined in RAL directive RAL-GZ 695.

1) Clarify admissibility of screw connection of window sill to the window frame prior to installation.

Ventilation window sill connection StoVentec Stone Massive with open joint

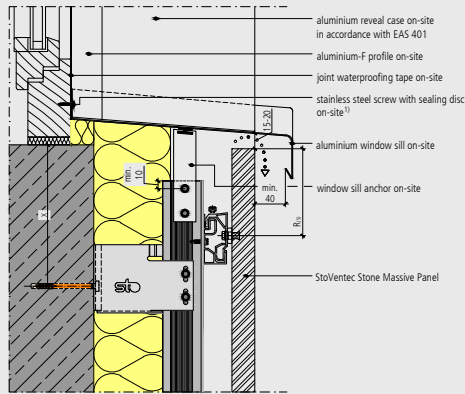

R₀ = edge spacing of undercut anchor in accordance with structural analyses
 X = minimum edge distance in accordance with dowel approval
 wind-proofing, window waterproofing and fixing in accordance with RAL and/or window manufacturer's specifications.
 Installation of window sill in accordance with installation directives defined in RAL directive RAL-GZ 695.

1) Clarify admissibility of screw connection of window sill to the window frame prior to installation.

Lateral window connection StoVentec Glass with sheet-metal casing

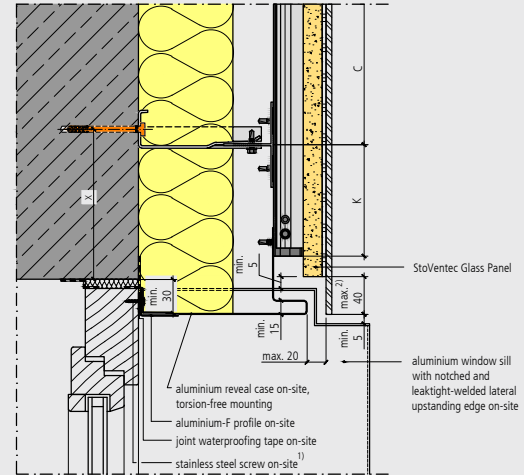

C = span width Sto-Agraffe Profile, see EAG 010 to 016

K = collar arm Sto-Agraffe Profile, see EAG 010 to 016

X = minimum edge distance in accordance with dowel approval

wind-proofing, window waterproofing and fixing in accordance with RAL and/or window manufacturer's specifications

1) Clarify admissibility of screw connection of F-Profile to the window frame prior to installation.

2) In case of unfavourable light conditions and certain colour shades, markings from the glass projection cannot be excluded

Lateral window connection StoVentec Stone Massive with stone panel

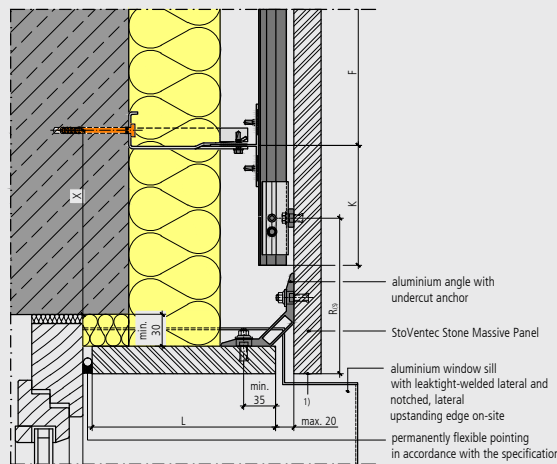

F = span width Sto-Agraffe Profile in accordance with structural analyses

K = collar arm Sto-Agraffe Profile in accordance with structural analyses

L = permissible projection of reveal element in accordance with structural analyses

R₀ = edge spacing of undercut anchor in accordance with structural analyses

X = minimum edge distance in accordance with dowel approval

wind-proofing, window waterproofing and fixing in accordance with RAL and/or window manufacturer's specifications.

1) Working on front edge analogous to natural stone element surface in agreement with system supplier

Notes

- When determining the window connections, the building tolerances must be considered.
- In case of ventilation joints > 20 mm, two Sto-Ventilation Profiles Alu have to be installed in a Z-shaped arrangement (alternatively, Z-shaped ventilation profiles) to keep out small animals.
- For correct waterproofing and installation of the windows and doors, the specifications according to RAL must be observed.
- Observe the required mounting height of the panels. See page 15.
- Wind-proofing and fixing of the windows in accordance with RAL and/or manufacturer's specifications

Connections

Lintel formation

Lintel ventilation StoVentec Glass with sheet-metal casing and open joint

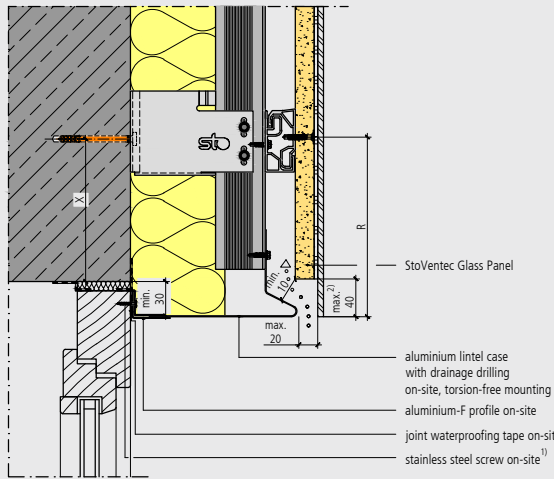

R = distance to edge in accordance with approval Z-33.2-659
 X = minimum edge distance in accordance with dowel approval
 wind-proofing, window waterproofing and fixing in accordance with RAL and/or window manufacturer's specifications.

- 1) Clarify admissibility of screw connection of F-Profile to the window frame prior to installation.
- 2) In case of unfavourable light conditions and certain colour shades, markings from the glass projection cannot be excluded.

Lintel formation with solar protection

Lintel ventilation StoVentec Glass with L-profile and open joint

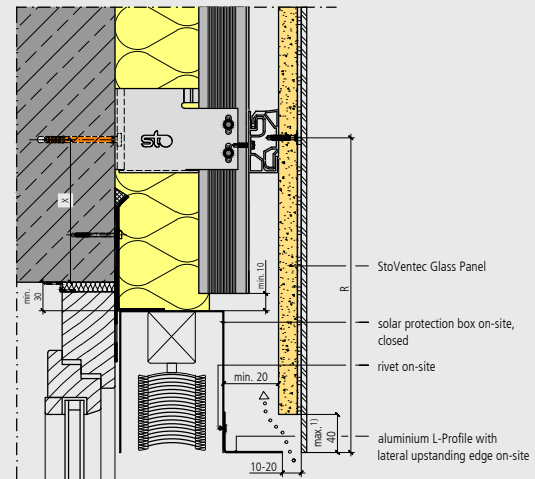

R = distance to edge in accordance with approval Z-33.2-659
 X = minimum edge distance in accordance with dowel approval
 wind-proofing, window waterproofing and fixing in accordance with RAL and/or window manufacturer's specifications.

- 1) In case of unfavourable light conditions and certain colour shades, markings from the glass projection cannot be excluded.

Lintel ventilation StoVentec Stone Massive with stone panel and open joint

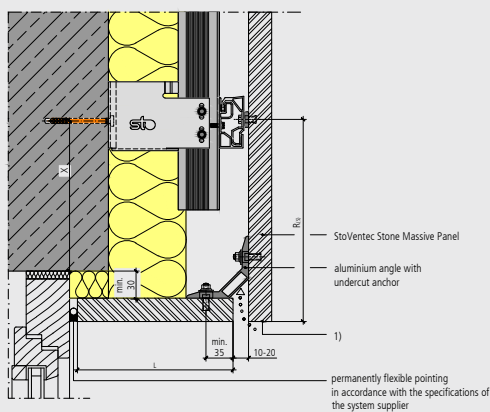

L = permissible projection of reveal element in accordance with structural analyses
 R_{0.0} = edge spacing of undercut anchor in accordance with structural analyses
 X = minimum edge distance in accordance with dowel approval
 wind-proofing, window waterproofing and fixing in accordance with RAL and/or window manufacturer's specifications.

- 1) Working on front edge analogous to natural stone element surface in agreement with system supplier

Lintel ventilation StoVentec Stone Massive with stone panel and open joint

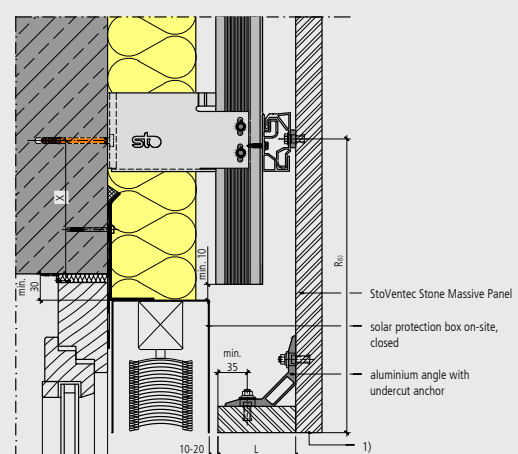

L = permissible projection of reveal element in accordance with structural analyses, minimum dimensions due to reveal angle
 R_{0.0} = edge spacing of undercut anchor in accordance with structural analyses
 X = minimum edge distance in accordance with dowel approval
 wind-proofing, window waterproofing and fixing in accordance with RAL and/or window manufacturer's specifications.

- 1) Working on front edge analogous to natural stone element surface in agreement with system supplier

Notes

When dimensioning the reveal and lintel elements, ensure that the lintel panels are 30 mm higher or the reveal panel is 60 mm longer. This allows overlapping at the corners.

Fire barrier

Horizontal fire barrier

Horizontal fire barrier in the area of the joints of the vertical carrier profiles¹⁾

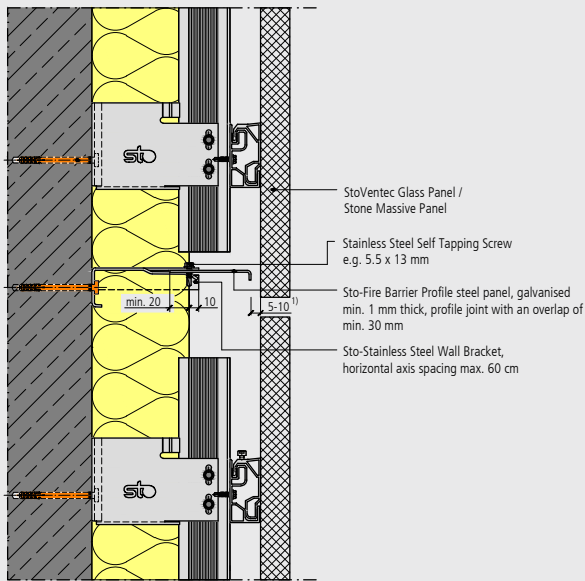

1) Free flow cross-section in the area of the fire barrier, due compliance with national specifications 50-100 cm²/m.

¹⁾ For insulation materials with a melting point below 1,000°C, the fire barrier must be continuously formed between the bare wall and the facade cladding.

Notes

To install fire barriers in ventilated facade constructions, the following building code specifications in the respective current version and edition must be considered:

- Sample and/or regional building regulations
- DIN 18516-1
- Sample list of the technical building regulations Part 1, Attachment 2.6/11

The specific design and location of the fire barriers must be coordinated with the fire protection expert responsible for the building project.

Ceiling cladding

Ceiling cladding with StoVentec Glass

Vertical section parallel (top) and transverse (bottom) to the agraffe

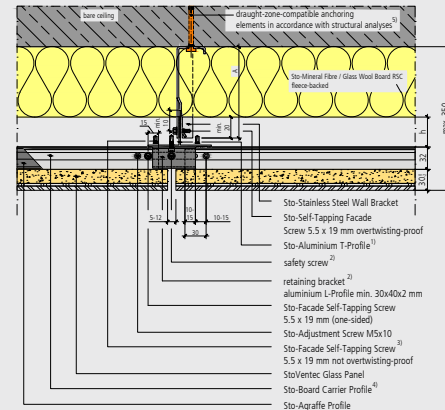

A = projection of wall bracket (see EAG 004)
h = ventilation airspace at least 20 mm in accordance with DIN 18516 s. h ≤ 150 mm, in case of ceiling planning h min. 30 mm
If necessary, diagonal reinforcement in accordance with structural specifications.
Secure ceiling elements with retaining bracket and one retaining bolt on each element to prevent them from becoming detached. Alternatively, fit 2 retaining bolts if zero-stress mounting is assured.

- 1) Arrange profile axes above and, where required, between, the panel joints.
- 2) Torsion-free screw connection in accordance with installation situation, either in the agraffe profile or through the panel joint (joint width min 10 mm, adjust screw head to joint width) in the T-Profile flange.
- 3) For execution see EAG 018
- 4) Rod length agraffe profile see EAG 010 to 016
- 5) If necessary, observe fire protection specifications

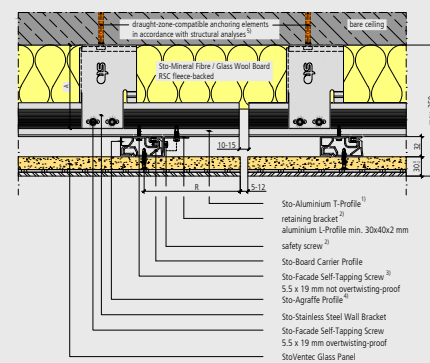

A = projection of wall bracket (see EAG 004)
If necessary, diagonal reinforcement in accordance with structural specifications.
Secure ceiling elements with retaining bracket and one retaining bolt on each element to prevent them from becoming detached. Alternatively, fit 2 retaining bolts if zero-stress mounting is assured.

- 1) Arrange profile axes above and, where required, between, the panel joints.
- 2) Torsion-free screw connection in accordance with installation situation, either in the agraffe profile or through the panel joint (min. joint width of 10 mm, match screw head to joint width) in T-profile flange.
- 3) For execution see EAG 018
- 4) Rod length agraffe profile see EAG 010 to 016
- 5) If necessary, observe fire protection specifications

Notes

- With suspension heights > 35 cm, it is recommended to fit the wall brackets with vertical pendulum rods and diagonal bracings in both directions.
- Standard detail drawings for the provision of system connections for ceiling claddings are available from Sto AG via www.sto.com.
- Anchor ceiling installations such as lamps, sprinklers, advertising panels, etc. separately to the bare ceiling. Required penetrations of the glass panels have to be discussed beforehand with the system supplier at the time the working drawings are prepared.
- Where required, observe the fire regulations when selecting the anchoring means.

Ceiling cladding

Connection - Ceiling/upward-oriented facade with open joint

StoVentec Glass

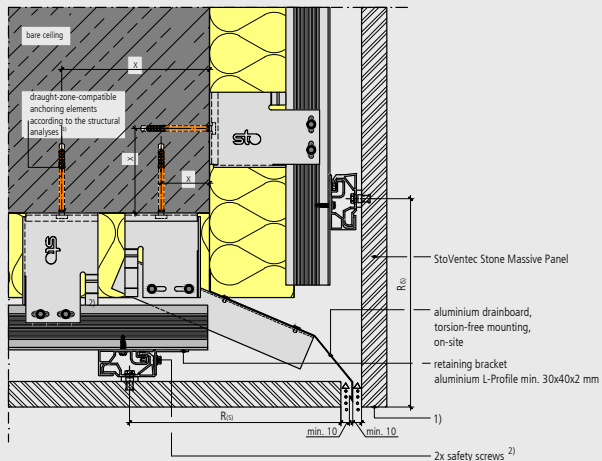

R_{ei} = edge spacing of undercut anchor in accordance with structural analyses
 X = minimum edge distance in accordance with dowel approval
If necessary, diagonal reinforcement in accordance with structural specifications.
Fit the ceiling elements before fitting the drainboard and installing the facade.

- 1) Working on front edge analogous to natural stone element surface in agreement with system supplier
- 2) Torsion-free screw connection in the agraffe profile
- 3) If necessary, observe fire protection specifications.

Note

Moisture seeping in through open system joints must be removed according to the design specifications.

Subsidiaries abroad

Austria
Sto Ges.m.b.H.
 9500 Villach
 Phone +43 4242 33133-0
www.sto.at

Belgium
Sto nv/sa
 1730 Asse
 Phone +32 2 4530110
www.sto.be

China
Shanghai Sto Ltd.
 201201 Shanghai
 Phone +86 2158 972295
www.sto.com.cn

Czech Republic
Sto s.r.o.
 251 70 Dobřejovice
 Phone +420 225 996 311
www.sto.cz

Denmark
Sto Danmark A/S
 2650 Hvidovre
 Phone +45 702 70143
www.stodanmark.dk

Finland
Sto Finexter Oy
 01730 Vantaa
 Phone +358 207 659191
www.stofi.fi

France
Sto S.A.S.
 95870 Bezons
 Phone +33 1 34345700
www.sto.fr

Hungary
Sto Építőanyag Kft.
 2330 Dunaharaszti
 Phone +36 24 510210
www.sto.hu

Ireland
Sto Ltd.
 Dublin 12
 Phone +353 1460 2305
www.sto.ie

Italy
Sto Italia srl
 50053 Empoli (FI)
 Phone +39 0571 94701
www.stoitalia.it

Malaysia
Sto SEA Sdn. Bhd.
 Baru Sri Alam
 81750 Masai
 Phone +607 388 1737
www.sto-sea.com

Netherlands
Sto Isoned bv
 4004 LH Tiel
 Phone +31 344 620666
www.sto.nl

Norway
Sto Norge AS
 0175 Oslo
 Phone +47 6681 3500
www.stonorge.no

Poland
Sto - ispo Sp. z o.o.
 03-872 Warszawa
 Phone +48 22 5116-102
www.sto.pl

Russia
OOO Sto
 119180 Moskva
 Phone +7495 974 1584

Singapore
Sto SEA Pte Ltd
 Singapore 575625
 Phone +65 64 533080
www.sto-sea.com

Slovak Republic
Sto s.r.o.
organizačná zložka
 83104 Bratislava 3
 Phone +421 2 44648142

Slovenia
Sto Ges.m.b.H.
Podružnica Ljubljana
 1000 Ljubljana
 Phone +386 1 4303 525
www.sto.com/si

Spain
Sto SDF Ibérica S.L.U.
 08302 Mataró (Barcelona)
 Phone +34 93 7415972
www.sto.es

Sweden
Sto Scandinavia AB
 581 10 Linköping
 Phone +46 13 377100
www.sto.se

Switzerland
Sto AG
 8172 Niederglatt/ZH
 Phone +41 44 8515353
www.stoag.ch

United Kingdom
Sto Ltd.
 Glasgow G52 4TG
 Phone +44 141 404 9000
www.sto.co.uk

USA
Sto Corp.
 Atlanta, GA 30331
 Phone +1 404 3463666
www.stocorp.com

Head office
Sto AG
 Ehrenbachstrasse 1
 79780 Stuehlingen
 Germany
 Phone +49 7744 57-0
 Fax +49 7744 57-2178
infoservice@sto.eu.com
www.sto.com

